

THE CHOICE OF NUMERICAL INTEGRATION METHODS FOR THE SUBSYSTEMS WITH THE DISTRIBUTED PARAMETERS

Serhiy RENDZINYAK, Vasyl KORUD

Department of Theoretical Electrical Engineering, Institute of Electrical Power Engineering and Control Systems, Lviv Polytechnic National University, 12 S. Bandera, 79013 Lviv, Ukraine

emd@polynet.lviv.ua, wk@polynet.lviv.ua

DOI: 10.15598/aeee.v13i5.1415

Abstract. *This article deals with methods of numerical modeling of heterogeneous electric circuits with distributed parameters for their possible use in the method of partitioning integration. We propose the use of modified Lax (LW) method for calculating the state of components with distributed parameters at the transient simulation in high-Q electric circuits, for example a transmission line. A comparison of transient simulation results in such circuits with the simulation results by known software systems is presented.*

Keywords

Heterogeneous electric circuit, LW method, transient simulation, transmission line.

1. Introduction

The current level of development of electrical engineering is characterized by a high degree of integration of heterogeneous components and devices for functions and principles of work. Electrical engineering technology is characterized by the complexity of the connection between these components, and the wide use of non-traditional and non-electrical elements that carry one's features. This leads to the formation of different types of individual components within a circuit. These complex electrical systems must be seen as a set of components with lumped parameters and components with distributed parameters. For their joint calculation some special algorithms should be used, including methods of separation processes [1], [2]. These methods are based on the decomposition of the primary scheme to various subcircuits, or the system of differential equations of different types into separate equations of a certain type. However, the use of particular

numerical processes for analysing dynamic processes is complex, and modern software does not guarantee its automation.

The problem of solving hyperbolic equations is quite difficult, therefore a lot of original papers devoted to this problem can be found [3], [4], [5], [6], [7]. Mathematical representation of differential equations using difference schemes is based on conservation laws [4]. Accordingly, the whole research area is covered with uniform or non-uniform mesh with corresponding time and space steps, and the aim is to find a solution in the mesh points. The choice of mesh in extreme points is defined by boundary conditions. Depending on the form of replacing derivative we can use different methods of solving equations that have certain stability and accuracy properties.

Researches [3], [4] have shown that the most famous ones are explicit and implicit difference Crank-Nicolson schemes providing a solution with the required accuracy of the coordinate steps Δx and on time Δt . Moreover, it is proved that the stability of solutions to linear hyperbolic equations depends on the smoothness of the coefficients and their own local conditions of stability.

A special place is occupied by numerical methods, based on the finite-difference methods (FDM). Building a system of difference equations, with adequate continuously variable arguments, essentially depends on a priori information about the original problem that further defines methods for solving these equations.

The quality difference schemes are determined by their stability and convergence. The family of explicit finite-difference methods most satisfies these specified conditions.

In general, the calculation of the transient dynamic modes of systems described by hyperbolic equations can be performed using the methods according to the following classification:

- direct numerical integration in time domain. It is advisable to use the explicit and implicit Crank-Nicolson methods, Galerkin method and wavelet solutions,
- solving equations in the frequency or the operator domain with subsequent conversion results in the time domain. Iterative algorithms of transformation are efficient for this class of methods. However, in this research these methods are used for illustrative purposes only because they do not provide an effective solution of the problem – the calculation of transient process taking into account the inner physical nature of the element.

Based on the optimal construction of different schemes, the so-called two-step Lax-Wendroff (LW) method, free of the drawbacks mentioned above, was developed [3]. In this method artificial units with half step are introduced. Such type modification greatly improves the stability and accuracy of the method. However, it should be noted that a detailed analysis of the methods of this class has shown that they are quite effective only for large-scale problems. In other cases, additional calculations by these methods are compensated gain, which is obtained with their application.

2. Use of the LW Method for Simulation of Transmission Line

To research the dynamic modes of nonlinear electric circuits with components characterized by a wave effect, let us consider the distribution parameters in the direction of wave propagation in space. These components of heterogeneous electric circuits are described by partial equations of hyperbolic type. In particular, it is a transmission line with mathematical model which can be represented as:

$$\begin{cases} -\frac{\partial u(x,t)}{\partial x} = R_0 i(x,t) + L_0 \frac{\partial i(x,t)}{\partial t}, \\ -\frac{\partial i(x,t)}{\partial x} = G_0 u(x,t) + C_0 \frac{\partial u(x,t)}{\partial t}. \end{cases} \quad (1)$$

Boundary conditions are given values of voltages and currents that are consistent with the voltages and currents of other components of the circuit at the input and output of a transmission line, and can change over time, which is taken into account when applying diakoptical methods of calculation of transients in heterogeneous electric circuits [8], [9], [10]. The most effective method for solving hyperbolic equations is Lax method, in which the value of a variable in a node of

the spatial grid is defined as $u_j^n = \frac{1}{2} (u_{j+1}^n + u_{j-1}^n)$, the time derivative is presented as $\frac{du}{dt} = \frac{u_{j+1}^n - u_j^n}{\Delta t}$, which results to an unstable computing process of the transmission lines with high-frequency signals. Therefore, it is proposed to use a more accurate approximation of the original method known as the Lax-Wendroff method [2], which improves the method in terms of calculation stability:

$$\begin{cases} \frac{du}{dt} = \frac{u_j^n - 0.5(u_{j-1}^{n-1} + u_{j+1}^{n-1})}{\Delta t}, \\ \frac{di}{dt} = \frac{i_j^n - 0.5(i_{j-1}^{n-1} + i_{j+1}^{n-1})}{\Delta t}. \end{cases} \quad (2)$$

Imposing a grid shown in Fig. 1 to the system of Eq. (1) gives the following scheme:

$$\begin{cases} -\frac{u_{t-1}^{x+1} - u_{t-1}^{x-1}}{2\Delta x} = \frac{R_0 (i_{t-1}^{x+1} + i_{t-1}^{x-1})}{2} + \\ + L_0 \left(\frac{i_t^x - 0.5(i_{t-1}^{x-1} + i_{t-1}^{x+1})}{\Delta t} \right), \\ -\frac{i_{t-1}^{x+1} - i_{t-1}^{x-1}}{2\Delta x} = \frac{G_0 (u_{t-1}^{x+1} + u_{t-1}^{x-1})}{2} + \\ + C_0 \left(\frac{u_t^x - 0.5(u_{t-1}^{x-1} + u_{t-1}^{x+1})}{\Delta t} \right). \end{cases} \quad (3)$$

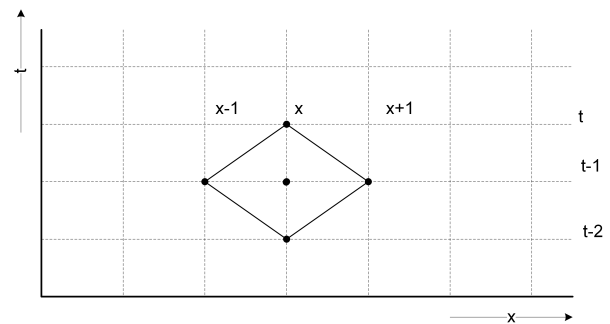

Fig. 1: A grid for the LW method.

Therefore, the solution of required variables relatively to the grid can be written down using the numerical formulas from Eq. (4).

The efficiency of the proposed approach Eq. (4) for the integration of hyperbolic equations was tested by the example of switching an unloaded transmission line at a constant voltage of 220 V with parameters $R_0 = 100 \Omega \cdot \text{km}^{-1}$, $L_0 = 490 \text{ mH} \cdot \text{km}^{-1}$, $C_0 = 1.66 \mu\text{F} \cdot \text{km}^{-1}$, $G_0 = 0.5 \mu\text{S} \cdot \text{km}^{-1}$. The simulation results are shown in Fig. 2, where $[U]=\text{V}$, $[t]=\text{s}$.

$$\begin{cases} u_t^x = (-\Delta (i_{t-1}^{x+1} - i_{t-1}^{x-1}) - \Delta t \Delta x G_0 (u_{t-1}^{x+1} + u_{t-1}^{x-1}) + C_0 \Delta x (u_{t-1}^{x-1} + u_{t-1}^{x+1})) / 2C_0 \Delta x, \\ i_t^x = (-\Delta (u_{t-1}^{x+1} - u_{t-1}^{x-1}) - \Delta t \Delta x R_0 (i_{t-1}^{x+1} + i_{t-1}^{x-1}) + L_0 \Delta x (i_{t-1}^{x-1} + i_{t-1}^{x+1})) / 2C_0 \Delta x. \end{cases} \quad (4)$$

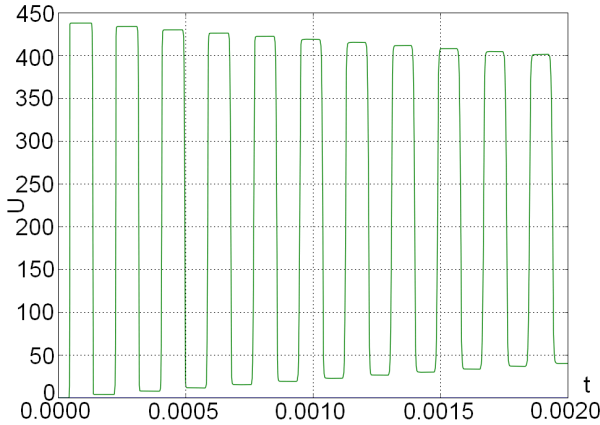

Fig. 2: The curve output voltage after switching transmission line for the LW method.

3. Comparison Simulations of Low-Loss Transmission Line by Known Software Systems

To verify the adequacy of the results a comparative simulation of a transmission line with small losses was carried out using MATLAB/Simulink, PSpice, and the author’s program implemented by the method of travelling waves, taking into account nonzero initial conditions. The following models were compared:

- transmission line with distributed parameters developed in MATLAB/Simulink in the form of Eq. (9) (Fig. 3),
- model of Transmission line with distributed parameters from SimPowerSystem Blockset,
- model proposed in [8].

In [8] partial differential equations of a single-phase overhead line are given in Laplace operator form, taking into account the initial conditions as follows:

$$\begin{cases} -\frac{du(p, x)}{dx} = (R_0 + pL_0) i(p, x) + L_0 i(0, x), \\ -\frac{di(p, x)}{dx} = (G_0 + pC_0) u(p, x) + C_0 u(0, x), \end{cases} \quad (5)$$

where the $u(p, x)$, $i(p, x)$ are voltage and current operators; $u(0, x)$, $i(0, x)$ are initial values of voltage and current at any point of line in time $t = 0$.

It is known that after differentiation Eq. (1) and replacing the derivatives $\frac{du(p, x)}{dx}$ and $\frac{di(p, x)}{dx}$ by the

expressions obtained from Eq. (5):

$$\begin{cases} \frac{d^2 u(p, x)}{dx^2} - \gamma^2 u(p, x) = -C_0 (R_0 + pL_0) u(0, x) + L_0 \frac{di(0, x)}{dx}, \\ \frac{d^2 i(p, x)}{dx^2} - \gamma^2 i(p, x) = -L_0 (G_0 + pC_0) i(0, x) + C_0 \frac{du(0, x)}{dx}, \end{cases} \quad (6)$$

where $\gamma = \sqrt{(R_0 + pL_0)(G_0 + pC_0)}$ is the propagation constant; $Z_c = \sqrt{(R_0 + pL_0)/(G_0 + pC_0)}$ is the wave resistance of a transmission line.

Then the solution of Eq. (6) is presented in the form of:

$$\begin{cases} u(p, x) = A_1(x) e^{\gamma x} + A_2(x) e^{-\gamma x}, \\ i(p, x) = B_1(x) e^{\gamma x} + B_2(x) e^{-\gamma x}, \end{cases} \quad (7)$$

with the additional conditions:

$$\begin{cases} \frac{dA_1(x)}{dx} e^{\gamma x} + \frac{dA_2(x)}{dx} e^{-\gamma x} = 0, \\ \frac{dB_1(x)}{dx} e^{\gamma x} + \frac{dB_2(x)}{dx} e^{-\gamma x} = 0. \end{cases} \quad (8)$$

If the line is without distortions, then $\gamma = \lambda(p + \alpha)$, where $\alpha = R_0/L_0 = G_0/C_0$, $\lambda = \sqrt{L_0 C_0}$. Based on applying of the inverse Laplace transform the originals of voltages and currents at the beginning (index p) and receiving end (index k) of the line can be obtained by Eq. (9), where $\tau = \lambda l$ is propagation time of an electromagnetic wave along the transmission line; $1(t - \tau)$ is Heaviside step function.

In the MATLAB/Simulink the simulation results of transient on the unloaded transmission line, switched to the voltage DC of 400 kV with the internal resistance, are shown in Fig. 4, the system SimPowerSystem – in Fig. 5, the system PSpice – in Fig. 6, the proposed scheme – in Fig. 7.

Also to determine the adequacy of the obtained results a comparative simulation of low-loss transmission line was carried out. The Fig. 6 shows the results of mathematical simulation of switching transmission line at a constant voltage obtained using PSpice. The use of these softwares for the transient simulation of nonlinear electric circuits leads to the obvious deviations that are directly connected with built-in models of components. Access to the correction of specific models is very limited, if possible at all.

$$\begin{cases} u_p(t) - Z_c i_p(t) = (u_k(t - \tau) - Z_c i_k(t - \tau)) e^{-\alpha\tau} + U(0) (1 - 1(t - \tau)) e^{-\alpha\tau}, \\ u_k(t) + Z_c i_k(t) = (u_p(t - \tau) + Z_c i_p(t - \tau)) e^{-\alpha\tau} + U(0) (1 - 1(t - \tau)) e^{-\alpha\tau}. \end{cases} \quad (9)$$

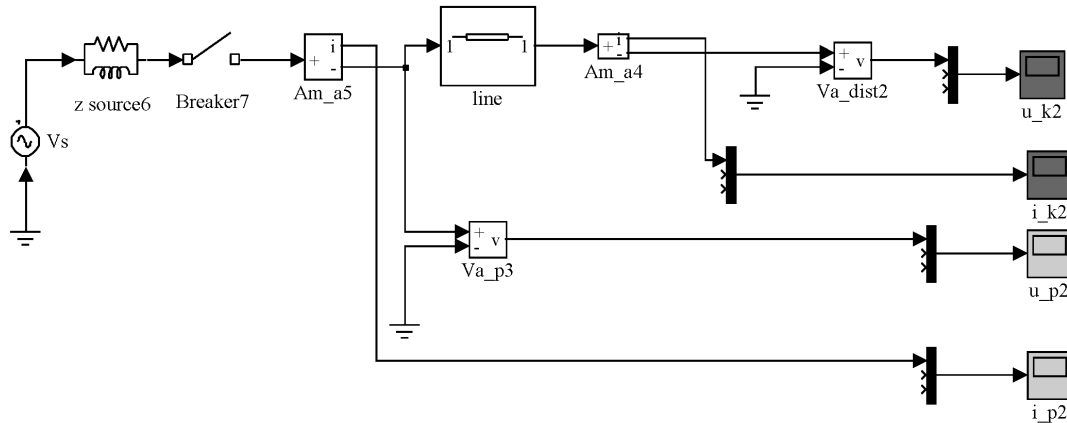

Fig. 3: Model of Transmission Line as Distributed Parameters Line in MATLAB/Simulink.

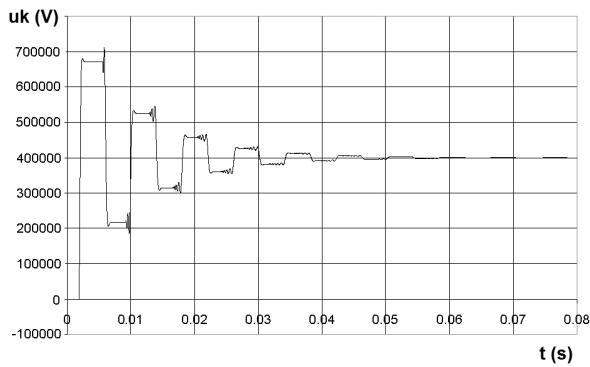

Fig. 4: Result of Simulation of Output Voltage of Transmission Line Obtained based on model Eq. (9) implemented into Simulink.

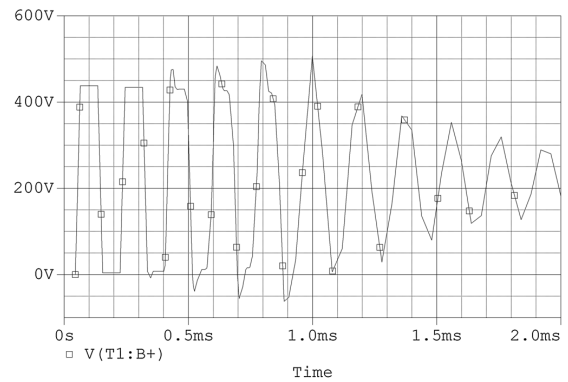

Fig. 6: Result of Simulation of Output Voltage of Transmission Line Obtained from PSpice.

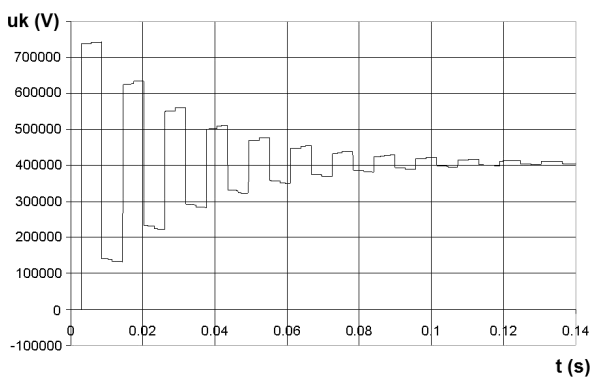

Fig. 5: Result of Simulation of Output Voltage of Transmission Line Obtained using the model from SimPowerSystem BlockSet.

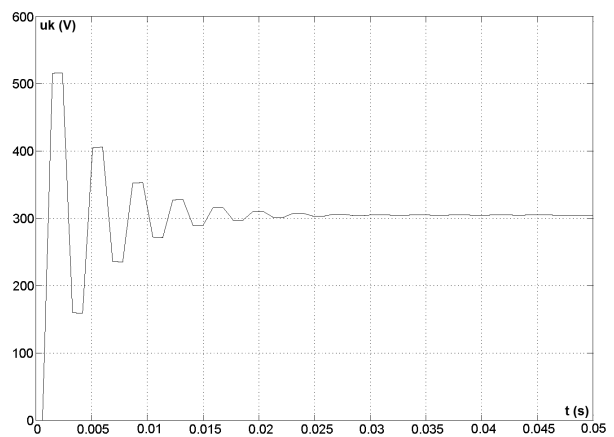

Fig. 7: The Curve of Output Voltage of Transmission Lines Obtained from the Simulation by Lax-Wendroff Method.

A comparison of the transient simulation of the electric circuit with a transmission line by Lax-Wendroff method shows that the proposed method for transient

simulation of heterogeneous high-Q circuits is more stable.

4. Conclusion

The use of known software systems to simulate the dynamic modes of heterogeneous electric circuits with high adequacy is too complicated because simplified models of necessary built-in components do not always take into account their topology, important parameters and nonlinearity of the elements.

The choice of the numerical integration method of hyperbolic equations is defined by the problem condition, i.e. initial and boundary conditions, and the accuracy of the solution. To study the problem of dynamic modes of nonhomogeneous electric circuits containing the components with lumped and distributed parameters, it is more expedient to use the Lax method [1], [2]. Applying this method makes it possible to construct difference equations of components with distributed parameters. This method has the following main characteristics: sufficient accuracy and stability during jumps of the boundary conditions. This is important for the use of diakoptical calculation methods, as well as parallelization of computation of dynamic modes of heterogeneous circuits.

References

- [1] LAX, P. D. and R. D. RICHTMAYER. Survey of the Stability of Linear Finite Difference Equations. *Communications on Pure and Applied Mathematics*. 1956, vol. 9, iss. 2, pp. 267–293. ISSN 1097-0312. DOI: 10.1002/cpa.3160090206.
- [2] MARCHUK, G. I. *Splitting Methods*. 1st ed. Moscow: Nauka, 1988.
- [3] LAX, P. D. and B. WENDROFF. On the Stability of Difference Schemes with Variable Coefficients. *Communications on Pure and Applied Mathematics*. 1962, vol. 15, iss. 4, pp. 363–371. ISSN 1097-0312. DOI: 10.1002/cpa.3160150401.
- [4] MARCHUK, G.I. *Methods of Computational Mathematics*. 1st ed. Moscow: Nauka, 1989.
- [5] LELARASMEE, E., A. E. RUEHLI and A. L. SANGIOVANNI-VINCENELLI. The Waveform Relaxation Method for Time Domain Analysis of Large Scale Integrated Circuits. *IEEE Transactions on Computer-Aided Design of Integrated Circuits and Systems*. 1982, vol. 1, iss. 3, pp. 131–145. ISSN 0278-0070. DOI: 10.1109/TCAD.1982.1270004.
- [6] LINIGER, W. Multistep and One-Leg Method to Implicit Mixed Differential Algebraic Systems. *IEEE Transactions on Circuits and Systems*. 1979,

vol. 26, iss. 9, pp. 755–762. ISSN 0098-4094. DOI: 10.1109/TCS.1979.1084697.

- [7] MITCHELL, A. R. Computational Methods in Partial Differential Equations. *International journal for numerical methods in engineering*. 1970, vol. 2, iss. 2, pp. 299. ISSN 0029-5981. DOI: 10.1002/nme.1620020216.
- [8] STAKHIV, P. and O. HOHOLYUK. Mathematical Modeling of Transmission Line Transients in MATLAB/Simulink Environment. *Acta Technica CSAV*. 2004, vol. 49, no. 1, pp. 89–105. ISSN 0001-7043.
- [9] RENDZINYAK, S., A. KORUD and B. MELNYK. Features of Subcircuits Matching with Components Described by Discrete Parameters Analysis of Electric Circuits Transient Processes. *Przeglad Elektrotechniczny*. 2007, vol. 2007, no. 2, pp. 154–156. ISSN 1731-6103.
- [10] STAKHIV, P., S. RENDZINYAK, O. HOHOLYUK and A. KORUD. Analysis of Electrical Circuits Transient Processes with Components Described by Discrete Parameters. In: *Proc. of Seventh International Conference in Advanced Methods in the Theory of Electrical Engineering Applied to Power Systems (AMTEE'05)*. Pilsen: IEEE, 2005, pp. 37–41. ISBN 80-7043-392-2.

About Authors

Serhiy RENDZINYAK was born in 1957 in Ukraine. He received his D.Sc. from Lviv Polytechnic National University, Ukraine in 2007 in electrical engineering. He is currently Professor of Department of Theoretical Electrical Engineering with Institute of Electrical Power Engineering and Control Systems, Lviv Polytechnic National University. His research interests include problems of parallelization of computational processes in the analysis of dynamic modes of electric circuits, research of transients in electric circuits by diakoptical methods.

Vasyl KORUD was born in 1949 in Ukraine. He received his Candidate of Science (Ph.D.) from Lviv Polytechnic Institute, USSR in 1984 in converter equipment. He is currently Associate Professor of Department of Theoretical Electrical Engineering with Institute of Electrical Power Engineering and Control Systems, Lviv Polytechnic National University. His research interests include electronic functional elements and applications.